

KA-3529

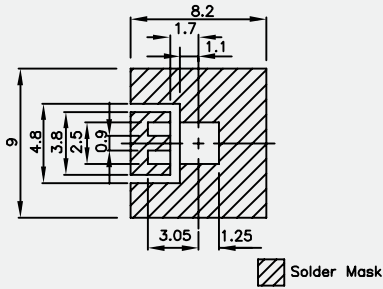

KA-3535

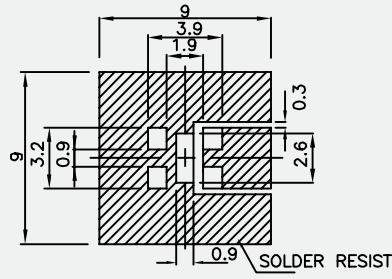

KAD1-9090

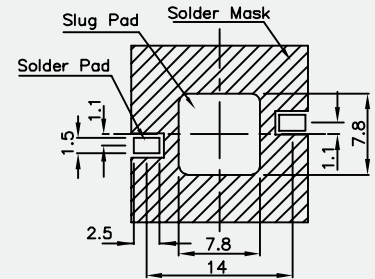

KAD1-1010

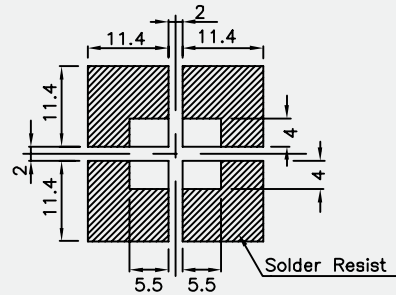

KA-8070, KADS-8070

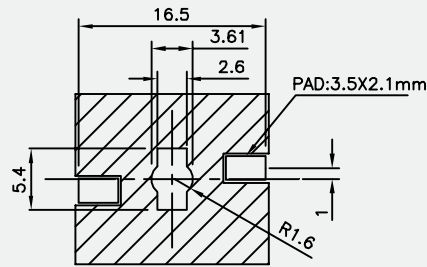

KA-8080, KADG1-8080

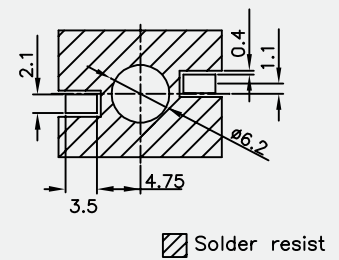

KT-2117

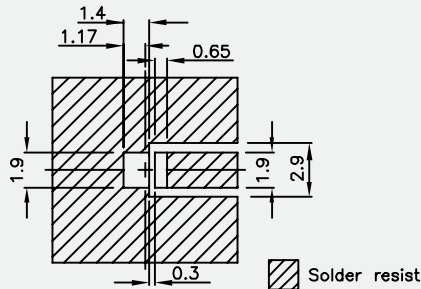

KT-2520

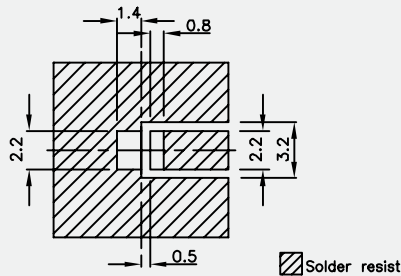

KT-3020

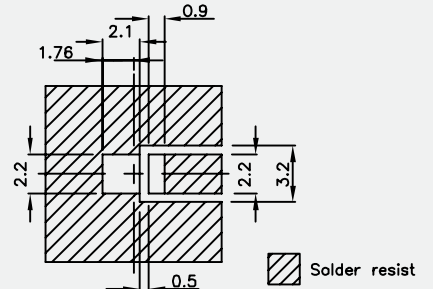

KT-3228

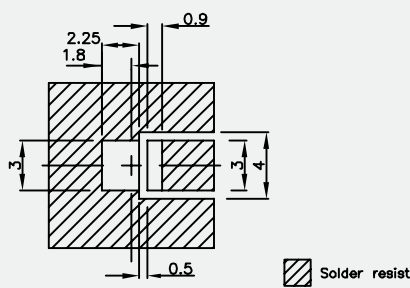

KT-3535

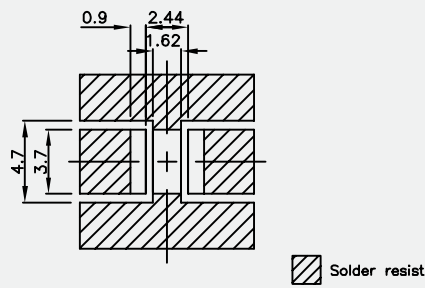

KT-5050

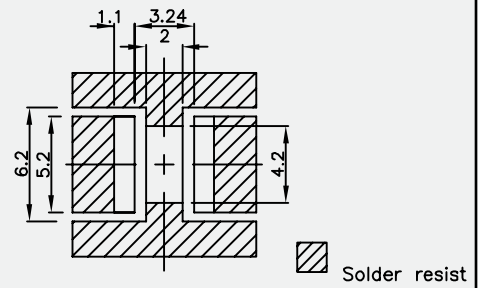

KT-5051

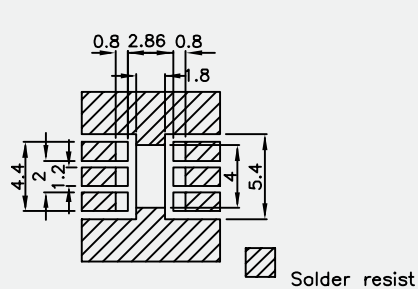

KTDG-8080

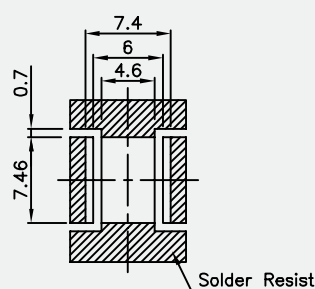

KTDG-9072

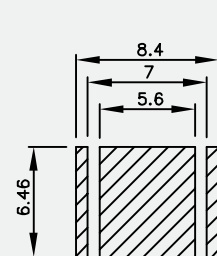

NOTES:
 1. All dimensions are in millimeters.
 2. Tolerance is ± 0.1 mm unless otherwise noted.

KAAF5051

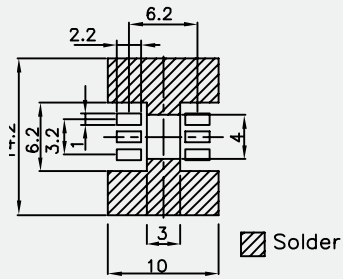

KA-2214

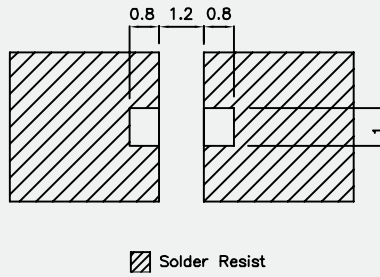

KA-3021

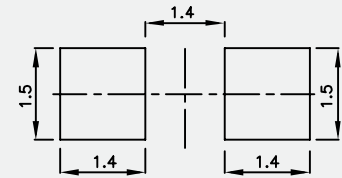

KA-3022-4.5SF

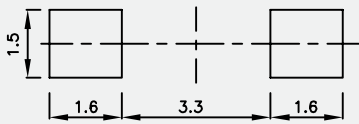

KA-3528 , KPED-3528

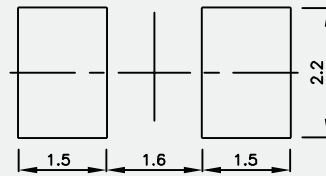

KPHHS-1005

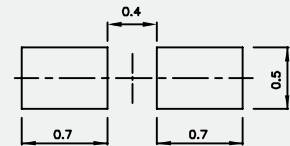

KP-1608, KPT-1608, KPTD-1608

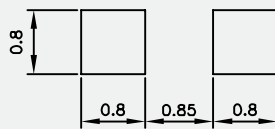

KP-2012, KPT-2012, KPTC-2012



KPHCM-2012

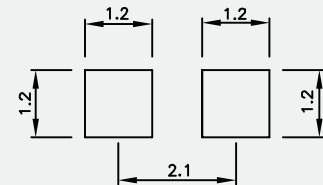

KP-23-F, KP-23xxx

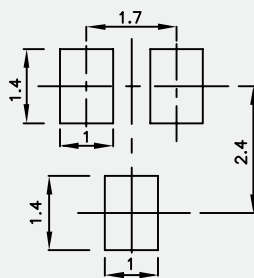

KPL-3015

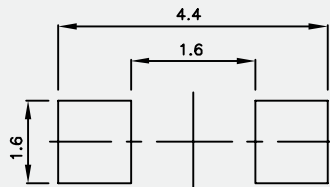

KP-3216, KPT-3216, KPC-3216, KPTD-3216

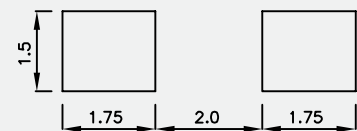

KPTL-3216

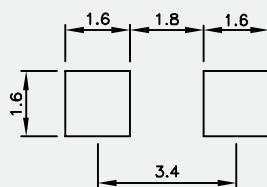

KPD-3224

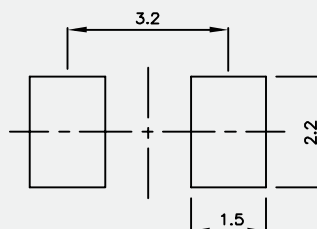

KPED-3820

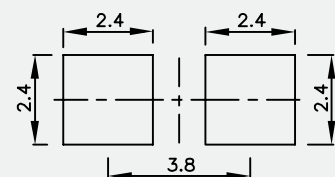

NOTES:

1. All dimensions are in millimeters.
2. Tolerance is ± 0.1 mm unless otherwise noted.

KPA-1606

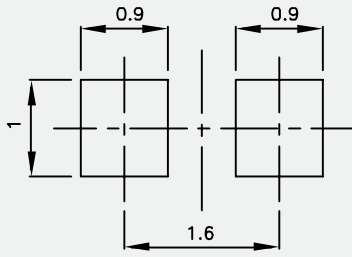

KPA-2106

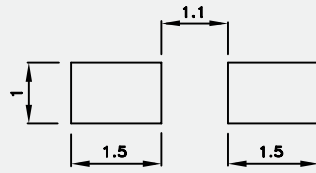

KPJA-2107

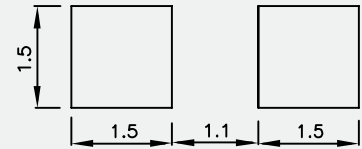

KPA-3010, KPBVA-3010

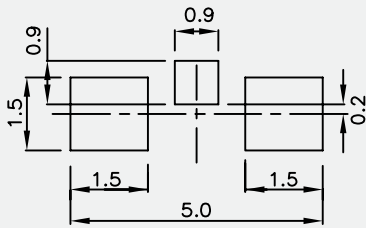

KPA-3210

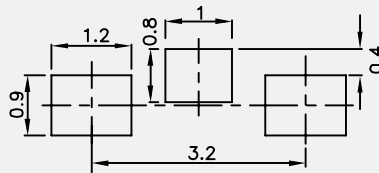

KA-2810A

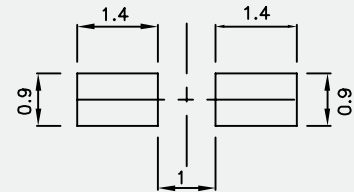

KA-4008

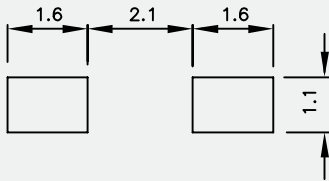

KA-4040

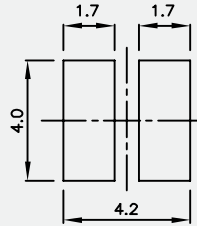

KPTB-1612

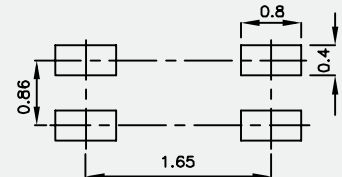

KPTB-1615

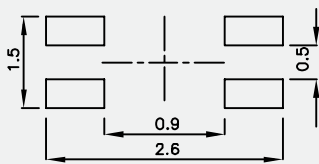

KPHBM-2012

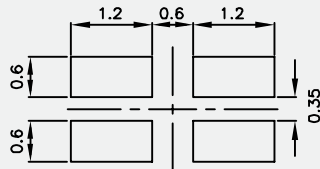

KM-23-F, KM-23xxx

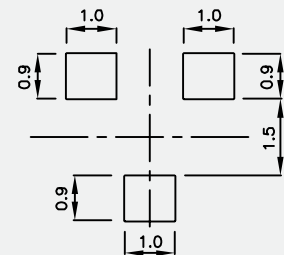

KPB-3025, KPBL-3025

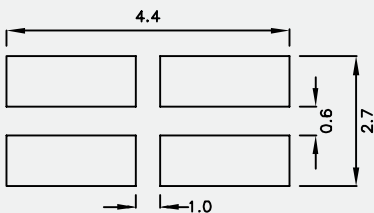

KPBD-3224

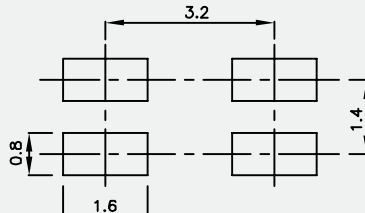

KA-2735

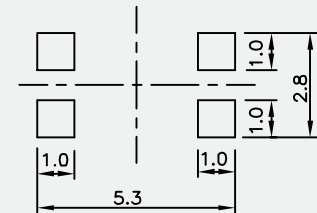

NOTES:
 1. All dimensions are in millimeters.
 2. Tolerance is ± 0.1 mm unless otherwise noted.

KAA-3528

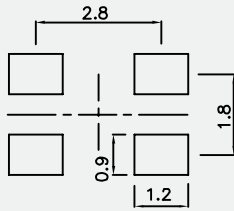

KA AF-5060

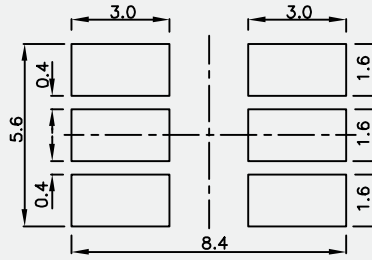

KM2520xxx03, KM-27xxx-03

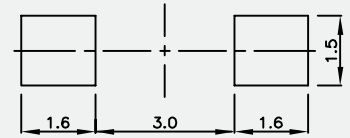

KM2520xxx08

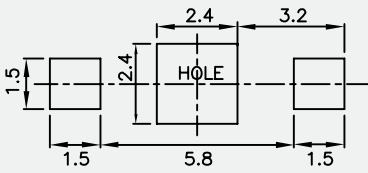

KM2520xxx09, KM-27xxx-09

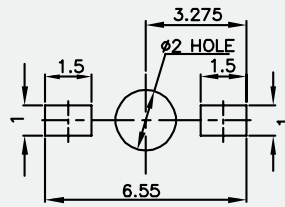

KPTR-3216

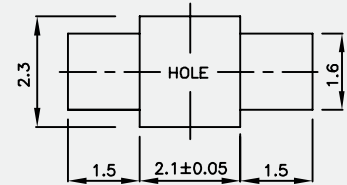

KPS-3227SP1C

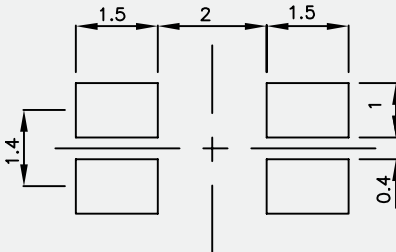

KPS-5130PD7C

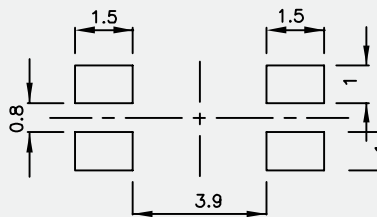

NOTES:
 1. All dimensions are in millimeters.
 2. Tolerance is ± 0.1 mm unless otherwise noted.

KCSX02

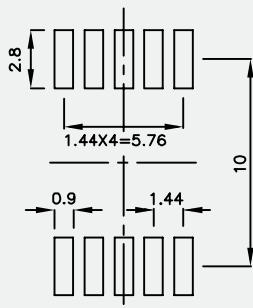

KCDX02

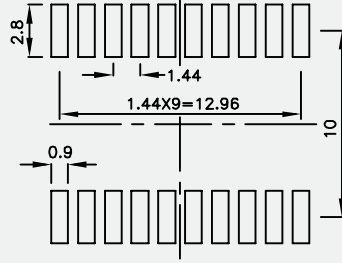

KCSX03

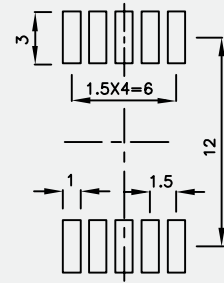

KCDX03

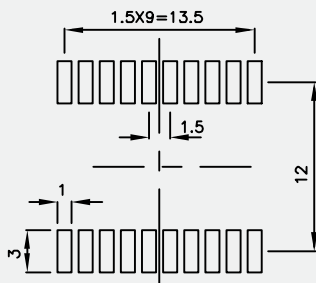

KCSX04

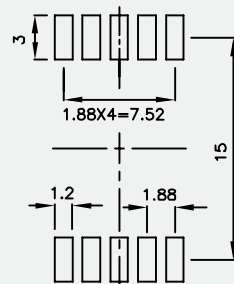

KCDX04

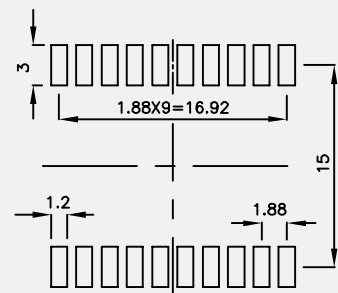

KCSX56

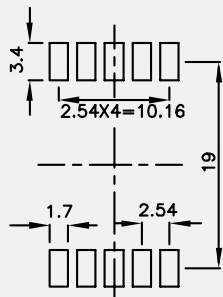

KCDX56

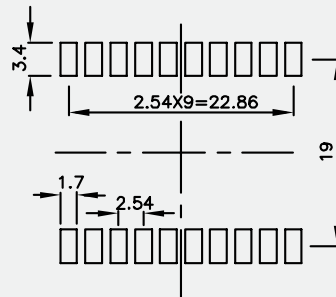

KCPSX04

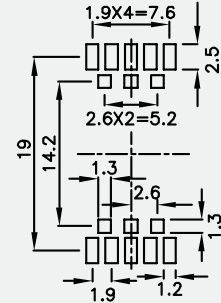

KCPDX04

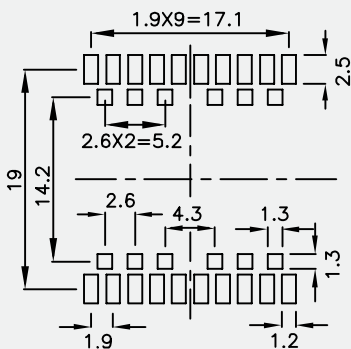

NOTES:
 1. All dimensions are in millimeters.
 2. Tolerance is ± 0.15 mm unless otherwise noted.